

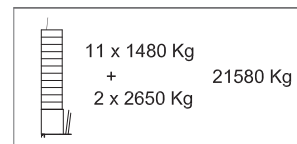

Peso del lastre / Weight ballast

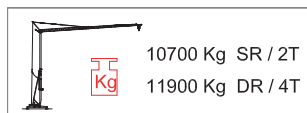

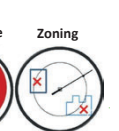

 Peso de la grúa sin lastre / Dead weight without ballast / Kontruktiongewicht ohne ballast / Poids de construction sans lest / Peso della gru senza zavorra

 Consultarnos - Consultateci - Consult us - Nous consulter - Auf anfrage - советоваться



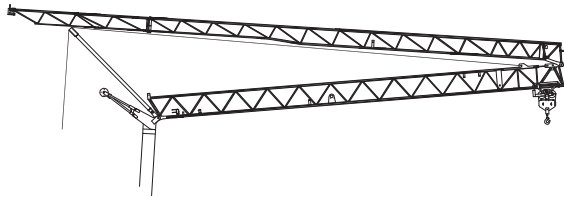

Curvas de cargas - Load diagrams - Lastkurven - Courbes de charges - Curve di carico - График грузоподъёмности





	11 x B = 16280 Kg
	2 x A = 5300 Kg
	21580 Kg

14,6	m	
2000	Kg	

	11 x B = 16280 Kg
	2 x A = 5300 Kg
	21580 Kg

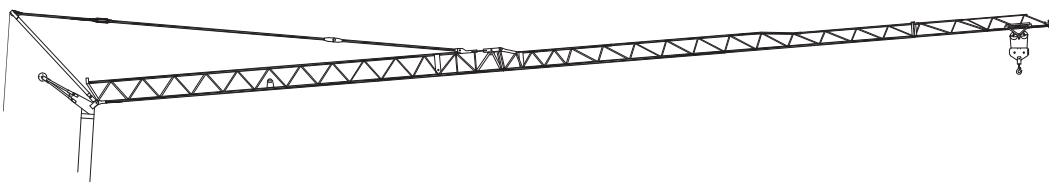
13,7	14,1	14,6	m	
4000	3866	3700	Kg	





	11 x B = 16280 Kg
	2 x A = 5300 Kg
	21580 Kg

18,25	20	22	24	26	28	30	32	m	
2000	1788	1590	1428	1293	1180	1083	1000	Kg	

10,5	12	14	16	18	18,25	20	22	24	26	28	30	32	m	
4000	3357	2743	2309	1987	1950	1738	1540	1378	1243	1130	1033	950	Kg	

19,75	20	22	24	26	28	30	m	
2000	1970	1753	1576	1430	1305	1200	Kg	



11,3	12	14	16	18	19,75	20	22	24	26	28	30	m	
4000	3691	3019	2545	2192	1950	1920	1703	1526	1380	1255	1150	Kg	

20,65	22,7	24,7	26,7	27,7	m	
2000	1783	1609	1464	1400	Kg	

11,75	12,7	14,7	16,7	18,7	20,65	22,7	24,7	26,7	27,7	m	
4000	3615	2994	2546	2208	1950	1733	1559	1414	1350	Kg	

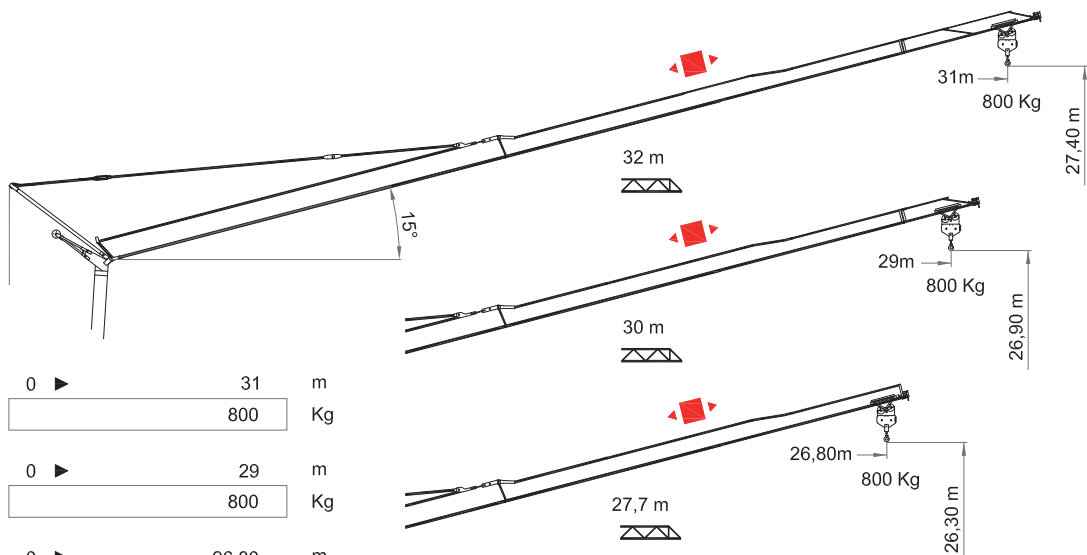





Flecha izada - Luffing jib - Ausleger in steilstellung - Flèche relevée - Braccio impennato



32 m	0	31	m
		800	Kg
30 m	0	29	m
		800	Kg
27,7 m	0	26,80	m
		800	Kg



Mecanismos - Mechanisms - Antriebe - Mécanismes - Meccanismi - Приводы

10Hp (7,5Kw) INV
HBG 21m Ø10mm

							
	m/min	5	20,5	40	2,5	10,25	20
	Kg	2000	2000	1000	4000	4000	2000
	Kw	7,5			7,5		
	m/min	19		45	19		45
	Kg	2000		2000	4000		2000
	Kw	2,2			2,2		
	r.p.m	0,25	0,5	0,8	0,25	0,5	0,8
	N.m.	30			30		
	Kw	4			4		



10Hp (7,5Kw) - INV

 2000/14/CEE 2005/88/CEE	 2006/95 /CEE	400V 50Hz I _{max} .= 24A Fuse= 25A	TOTAL POWER 15 KVA	GENERATOR 25 KVA	100m 4x6mm ²	150m 4x10mm ²	200m 4x10mm ²
---	--	---	--------------------------	---------------------	----------------------------	-----------------------------	-----------------------------

-  Elevación / Hoisting / Heben / Levage / Sollevamento
-  Distribución / Trolleying / Katzfahren / Distribution / Distributions
-  Orientación / Slewing / Schwenken / Orientation / Rotazione
-  Montaje / Erection / Montage / Montage / Montaggio

Dimensiones y transporte - dimensions and transport - Abmessungen und Transport- dimensions et des transporte - dimensioni e trasporti - Размеры и транспорта

H

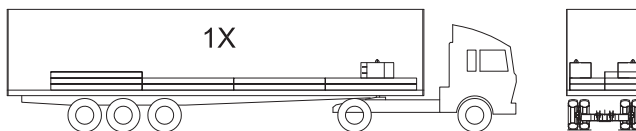
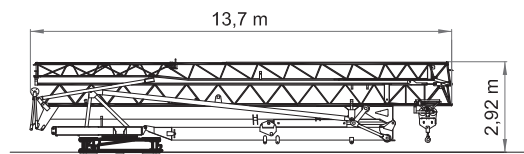
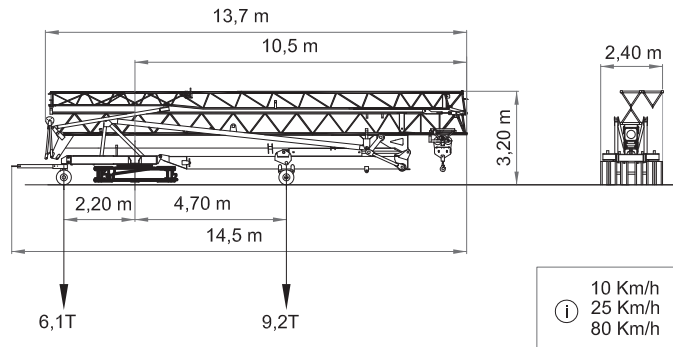

P1

P1	17760 kg
P2	15800 kg
Ptot	33560 kg

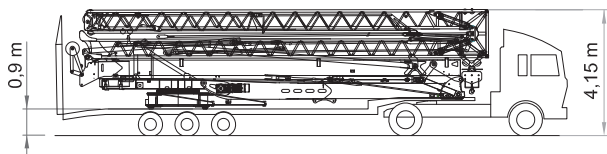

P2

1 X GONDOLA 0,9m

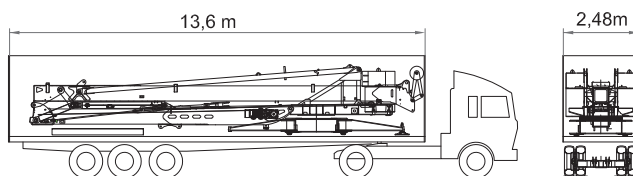

P1

P1	14870 kg
P2	18690 kg
Ptot	33560 kg

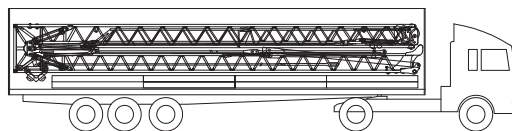

P2

2 X STANDARD TRAILER

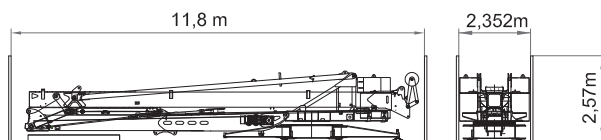

P1

P1	20630 kg
P2	12930 kg
Ptot	33560 kg



P2

1 X OPEN TOP 40'

1 X HIGH CUBE 40'

Montaje - Erection - Montage - Montage - Montaggio

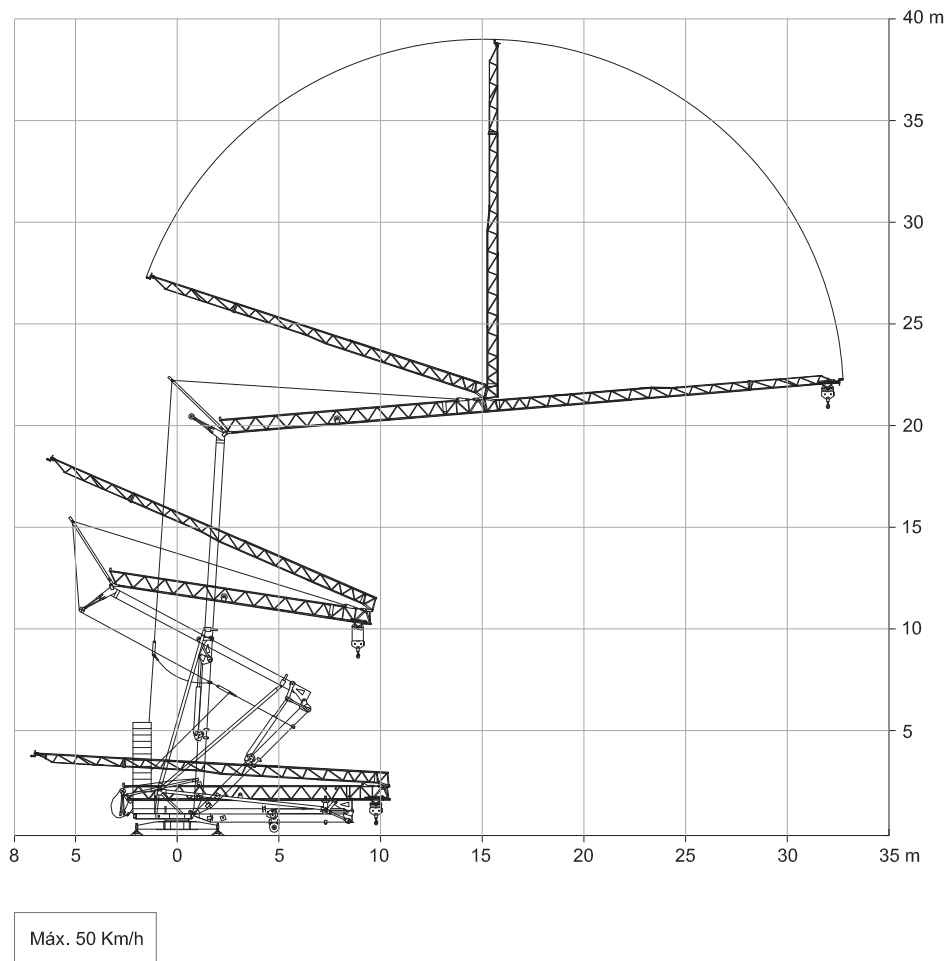

		L (m)	W (m)	H (m)	Kg
Eje de transporte delantero Road transport axle front / Transportachse vorne Essieux de transport avant / Asse di trasporto anteriore		2,05	1,24	1,07	440
Eje de transporte trasero / Road transport axlebehind / Transportachse hinten / Essieux de transport arrière / Asse di trasporto posteriore		0,89	2,40	0,89	346
Eje de transporte trasero con freno Transportachse hinten mit brense Essieux de transport arrière avec frein Asse di trasporto posteriore con freno		1,25	2,40	1,35	960